

PRODUCT DATASHEET

SP CBO ADJ V 6W CPS DIM 60DEG IP65 WT

SPOT COMBO ADJUST | Coverable spot with CCT, power select and dimming function, in adjustable version



Areas of application

- Direct replacement for recessed spotlights with halogen lamps
- General illumination
- Hotel rooms and corridors
- Bars, restaurants
- Residential interiors

Product benefits

- Color temperature adjustment via switch on the back of the spot
- Power select: Brightness adjustment via a switch on the driver
- Coverable with most of the isolation material

Product features

- Color temperature switch (CCT): 2700 K, 3000 K, 4000 K
- Power select option available to select between 2 lumen packages
- Type of protection: IP65 (room side)
- Housing material: polycarbonate (PC)
- Dimmable (with many common dimmers, see also www.ledvance.com/dim)



TECHNICAL DATA

Electrical data

Nominal wattage	6 W / 4 W
Nominal voltage	220...240 V
Mains frequency	50...60 Hz
Nominal current	27...19 mA
Inrush current	0.86 A
Inrush current time T_{h50}	28 μ s
Max. number of luminaires per miniature circuit breaker B16	40
Max. number of luminaires per miniature circuit breaker C10	40
Max. number of luminaires per miniature circuit breaker C16	40
Power factor λ	> 0.90
Total harmonic distortion	< 40 %
Protection class	II
Operating mode	Electronic control gear (ECG)
Dimming interface	Phase Cut

Photometrical data

Luminous flux	600 lm / 400 lm ¹⁾
Luminous efficacy	92 lm/W ²⁾
Color temperature	2700 K / 3000 K / 4000 K
Light color (designation)	Warm White / Cool White
Color rendering index Ra	> 90
Standard deviation of color matching	< 6 sdc _m
Luminous intensity	610 cd
Low flicker	Yes
Flickering metric (Pst LM)	<1
Stroboscope effect metric (SVM)	<0.4
Photobiological safety group acc. to EN62778	RG1
Beam angle	60 °

1) 580 lm / 380 lm @3000K, 550 lm / 350 lm @2700K

2) 97 lm/W / 95 lm/W @3000K, 92 lm/W / 88 lm/W @2700K

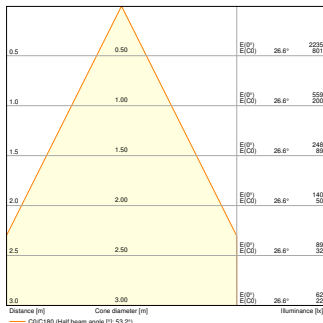

SP CBO ADJ V 6W 927 CPS DIM
60DEG IP65WT 550lm

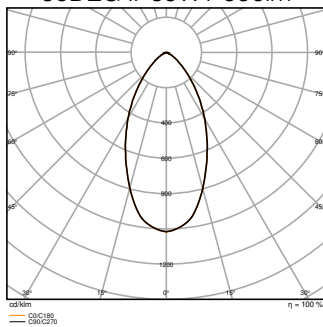

SP CBO ADJ V 6W 930 CPS DIM
60DEG IP65WT 580lm

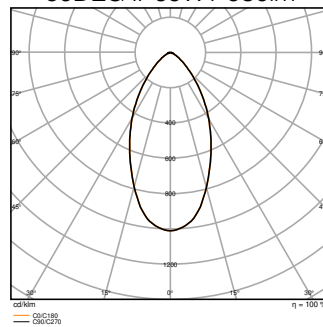

SP CBO ADJ V 6W 940 CPS DIM
60DEG IP65WT 600lm

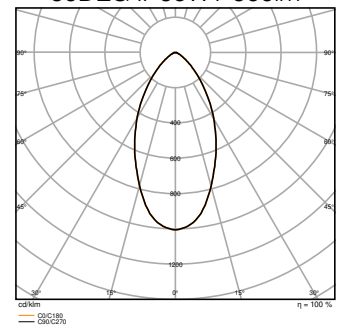

SP CBO ADJ V 6W 927 CPS DIM
60DEG IP65WT 550lm

SP CBO ADJ V 6W 930 CPS DIM
60DEG IP65WT 580lm

SP CBO ADJ V 6W 940 CPS DIM
60DEG IP65WT 600lm

Dimensions & Weight

Diameter	81.50 mm
Height	48.00 mm
Product weight	195.00 g
Cable length	600 mm

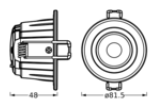

SP ADJ3,6/5.5W927/30/40
60DEGIP65WT

Materials & Colors

Product color	White
Housing color	White

Body material	Aluminum Plastic
Cover material	Plastic
Light emitting surface material	Plastic
Glow Wire Test according to IEC 60695-2-12	850 °C
Mercury content	0.0 mg

Application & Mounting

Ambient temperature range	-20...+40 °C
Temperature range at storage	-20...+80 °C
Type of connection	Push terminal
Type of protection	IP65/IP20
Protection class IK (shock resistance)	IK03
Dimmable	Yes
Type of dimming	PHASE CUT
Mounting type	Recessed
Mounting location	Ceiling
Application environment	Indoor
Mounting diameter	68 mm
Mounting depth	48 mm
Adjustable	Yes
With light source	Yes

Lifespan

Lifespan L70/B50 at 25 °C	50000 h ¹⁾
Lifespan L80/B10 at 25 °C	35000 h ¹⁾
Lifespan L80/B50 at 25 °C	37000 h
Lifespan L90/B10 at 25 °C	18000 h
Number of switching cycles	25000

¹⁾ t[h]: L70 / B50 @ 25 °C (Ta), t[h]: L80 / B10 @ 25 °C (Ta), t[h]: L90 / B10 @ 25 °C (Ta)

Control gear

Output current	100 mA
ECG - Output ripple current	< 30 %
ECG - Length	100 mm
ECG - Width	46,5 mm
ECG - Height	25,5 mm





Certificates & Standards

Standards	CE / UKCA / EAC
Luminaire with limited surface temperature, "D sign"	No
Ball shot safe	No
Replaceable light source (EPREL)	Not replaceable

Additional product data

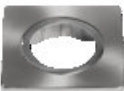
Added function	MULTI SELECT
----------------	--------------







Accessories Optional



Product image	Product name	EAN
	SP CBO RING ADJ SQUARE BN	4099854097959
	SP CBO RING ADJ ROUND BK	4099854097911
	SP CBO RING ADJ SQUARE WT	4099854097973
	SP CBO RING ADJ ROUND BN	4099854097935
	SP CBO RING ADJ SQUARE BK	4099854097997



EQUIPMENT / ACCESSORIES

- Already equipped with white round ring
- Additional cover rings separately available in round and square shape and in different colors

DOWNLOAD DATA

Documents and certificates		Document name
	User instruction / safety instructions	SP CBO FIX/ADJ V 6W CPS DIM60DEG IP65 WT
	Legal information	Legal Insert SPOT COMBO
	Legal information	Informationstext 18 Abs 4 ElektroG
	Declarations of conformity	SPOT COMBO GEN2
	Declarations of conformity UKCA	SPOT COMBO GEN2
Photometric and lighting design files		Document name
	IES file (IES)	SP CBO ADJ V 6W 927 CPS DIM 60DEG IP65WT 550lm
	IES file (IES)	SP CBO ADJ V 6W 930 CPS DIM 60DEG IP65WT 580lm
	IES file (IES)	SP CBO ADJ V 6W 940 CPS DIM 60DEG IP65WT 600lm
	LDT file (Eulumdat)	SP CBO ADJ V 6W 927 CPS DIM 60DEG IP65WT 550lm
	LDT file (Eulumdat)	SP CBO ADJ V 6W 930 CPS DIM 60DEG IP65WT 580lm
	LDT file (Eulumdat)	SP CBO ADJ V 6W 940 CPS DIM 60DEG IP65WT 600lm
	ULD file (DIALux)	SP CBO ADJ V 6W CPS DIM60DEG IP65WT
	ROLF file (RELUX)	SP CBO ADJ V 6W CPS DIM60DEG IP65WT
	UGR file (UGR table)	SP CBO ADJ V 6W 927 CPS DIM 60DEG IP65WT 550lm
	UGR file (UGR table)	SP CBO ADJ V 6W 930 CPS DIM 60DEG IP65WT 580lm
	UGR file (UGR table)	SP CBO ADJ V 6W 940 CPS DIM 60DEG IP65WT 600lm
	Light distribution curve type cone	SP CBO ADJ V 6W 927 CPS DIM 60DEG IP65WT 550lm
	Light distribution curve type cone	SP CBO ADJ V 6W 930 CPS DIM 60DEG IP65WT 580lm
	Light distribution curve type cone	SP CBO ADJ V 6W 940 CPS DIM 60DEG IP65WT 600lm

Photometric and lighting design files	Document name
	Light distribution curve type polar
	Light distribution curve type polar
	Light distribution curve type polar

CAD/BIM files	Document name
	BIM Revit 3D
	BIM Revit 3D
	CAD STEP 3D

LOGISTICAL DATA

Product code	Packaging unit (Pieces/Unit)	Dimensions (length x width x height)	Gross weight	Volume
4058075845091	Folding box 1	77 mm x 107 mm x 98 mm	241.00 g	0.81 dm ³
4058075845107	Shipping box 20	402 mm x 228 mm x 222 mm	5172.00 g	20.35 dm ³

The mentioned product code describes the smallest quantity unit which can be ordered. One shipping unit can contain one or more single products. When placing an order, for the quantity please enter single or multiples of a shipping unit.

ADDITIONAL CATALOG INFORMATION

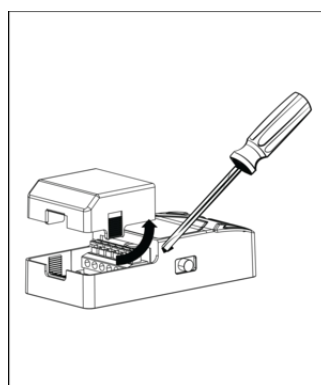
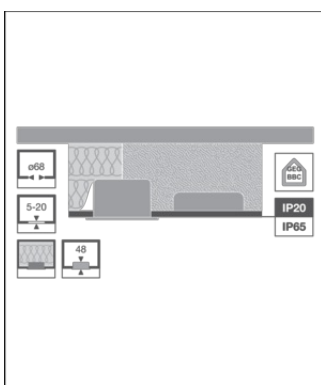

References / Links

– For Guarantee see www.ledvance.com/guarantee

DISCLAIMER

Subject to change without notice. Errors and omission excepted. Always make sure to use the most recent release.