

PRODUCT DATASHEET

DL ALU DALI DN 150 14 W 6500 K IP44/IP20 WT

DOWNLIGHT ALU DALI | Downlight luminaires with aluminum housing and DALI driver



Areas of application

- Direct replacement for luminaires with compact fluorescent lamps
- General illumination
- Public areas
- Stairways
- Corridors
- Foyers
- Shops

Product benefits

- Advanced functionality due to already included DALI driver
- DALI driver with individual luminaire current set-up already installed
- High luminous efficacy
- Energy savings up to 60 % (compared to luminaires that use CFL lamps)
- Very homogenous light
- Functional design
- Easy installation with fast connection
- 5 years guarantee

Product features



- Advanced applications with DALI light installations
- Diameter of required ceiling cut-out: 150 mm or 200 mm (depending on version)
- Type of protection: IP44

TECHNICAL DATA

Electrical data

| | |
|-------------------------------------------------------------|---------------------|
| Nominal wattage | 14.00 W |
| Nominal voltage | 220...240 V |
| Mains frequency | 0/50/60 Hz |
| Nominal current | 100.000 mA |
| Inrush current | 20 A |
| Inrush current time T_{h50} | 140 μ s |
| Max. number of luminaires per miniature circuit breaker B16 | 32 |
| Max. number of luminaires per miniature circuit breaker C10 | 31 |
| Max. number of luminaires per miniature circuit breaker C16 | 53 |
| Power factor λ | > 0.90 |
| Total harmonic distortion | < 20 % |
| Protection class | II |
| Operating mode | External LED driver |
| Dimming interface | DALI-2 |

Photometrical data

| | |
|----------------------------------------------|----------------------|
| Luminous flux | 1330 lm |
| Luminous efficacy | 95 lm/W |
| Color temperature | 6500 K |
| Light color (designation) | Cool Daylight |
| Color rendering index Ra | > 80 |
| Standard deviation of color matching | < 6 sdc _m |
| Luminous intensity | - |
| Flickering metric (Pst LM) | - |
| Stroboscope effect metric (SVM) | - |
| Photobiological safety group acc. to EN62778 | RG0 |
| Photobiological safety group acc. to EN62471 | RG0 |
| Beam angle | 100 ° |

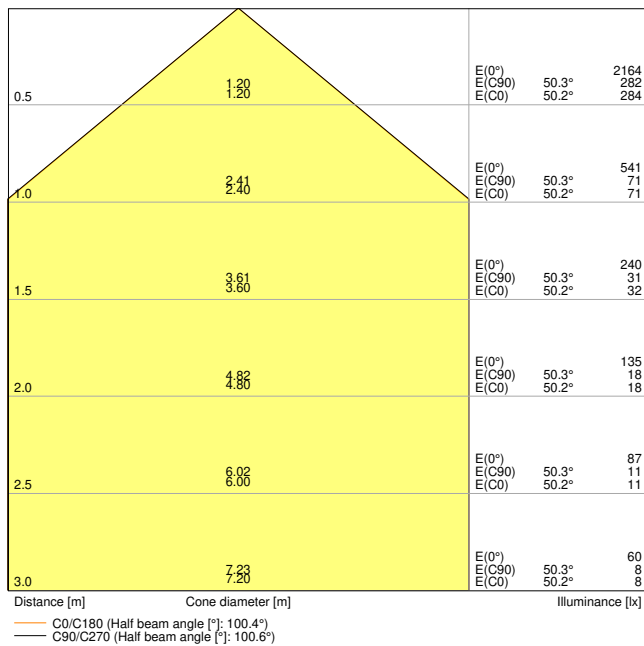

DL ALU DALI DN150 14W 6500K WT IP44

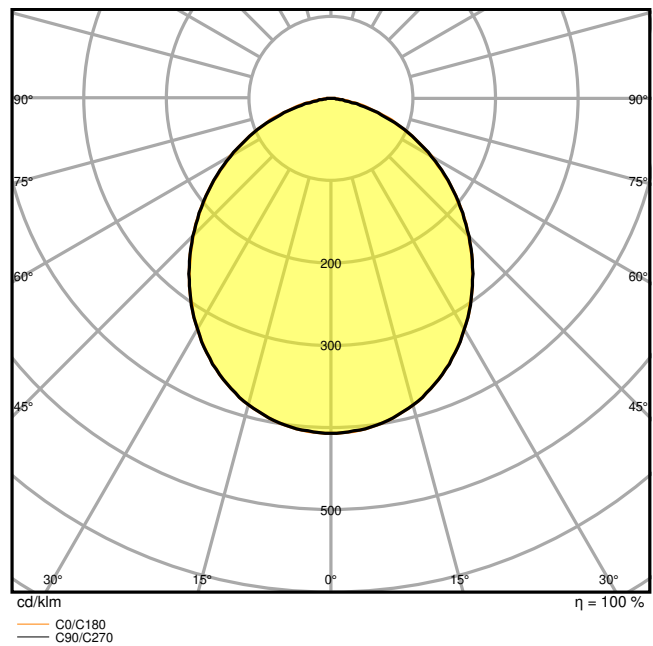

DL ALU DALI DN150 14W 6500K WT IP44

Dimensions & Weight

| | |
|----------------|-----------|
| Diameter | 160.00 mm |
| Height | 52.00 mm |
| Product weight | 360.00 g |

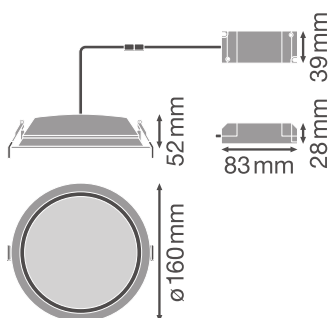

DL ALU DN150 14W

Materials & Colors

| | |
|---------------|-------|
| Product color | White |
| Housing color | White |

| | |
|--------------------------------------------|-------------------------------|
| Body material | Aluminum |
| Cover material | Polymethylmethacrylate (PMMA) |
| Glow Wire Test according to IEC 60695-2-12 | 650 °C |
| Mercury content | 0.0 mg |

Application & Mounting

| | |
|----------------------------------------|----------------------------|
| Ambient temperature range | -20...+45 °C |
| Type of connection | Screwless terminal, 5-Pole |
| Type of protection | IP44/IP20 |
| Protection class IK (shock resistance) | IK02 |
| Dimmable | Yes |
| Type of dimming | DALI |
| Mounting type | Recessed |
| Mounting location | Ceiling |
| Application environment | Indoor |
| Mounting diameter | 150 mm |
| Mounting depth | 100 mm |
| With light source | Yes |

Lifespan

| | |
|----------------------------|-----------------------|
| Lifespan L70/B50 at 25 °C | 50000 h ¹⁾ |
| Lifespan L80/B10 at 25 °C | 45000 h ¹⁾ |
| Lifespan L80/B50 at 25 °C | 45000 h |
| Lifespan L90/B10 at 25 °C | 30000 h |
| Number of switching cycles | 100000 |

¹⁾ t[h]: L70 / B50 @ 25 °C (Ta), t[h]: L80 / B10 @ 25 °C (Ta), t[h]: L90 / B10 @ 25 °C (Ta)

Certificates & Standards

| | |
|------------------------------------------------------|-----------------|
| Standards | CE / CB / EAC |
| Luminaire with limited surface temperature, "D sign" | No |
| Ball shot safe | No |
| Replaceable light source (EPREL) | Not replaceable |

Additional product data

| | |
|-----------------------|--------------|
| Number of illuminants | Not relevant |
| Added function | VIVARES |











Accessories Optional

| Product image | Product name | EAN |
|-----------------------------------------------------------------------------------|-------------------|---------------|
|  | EM CONVERSION BOX | 4058075237025 |



Safety advice

- All electrical connections must be made by a qualified person.
- Caution, risk of electric shock.
- The luminaires are not suitable for covering with thermally insulated material.

DOWNLOAD DATA

| Documents and certificates | | Document name |
|------------------------------------------------------------------------------------|----------------------------------------|-------------------------------------|
|  | User instruction / safety instructions | DOWNLIGHT ALU DALI |
|  | Legal information | LSI DL ALU DALI |
|  | Legal information | Informationstext 18 Abs 4 ElektroG |
|  | Declarations of conformity | Declaration of conformity |
|  | Declarations of conformity UKCA | DL ALU DALI WT IP44 |
| Photometric and lighting design files | | Document name |
|  | IES file (IES) | DL ALU DALI DN150 14W 6500K WT IP44 |
|  | LDT file (Eulumdat) | DL ALU DALI DN150 14W 6500K WT IP44 |
|  | ULD file (DIALux) | DL ALU DALI DN150 14W-6500K WT IP44 |
|  | ROLF file (RELUX) | DL ALU DALI DN150 14W-6500K |
|  | UGR file (UGR table) | DL ALU DALI DN150 14W 6500K WT IP44 |
|  | Light distribution curve type cone | DL ALU DALI DN150 14W 6500K WT IP44 |

| Photometric and lighting design files | | Document name |
|----------------------------------------------------------------------------------|-------------------------------------|-------------------------------------|
|  | Light distribution curve type polar | DL ALU DALI DN150 14W 6500K WT IP44 |

| CAD/BIM files | | Document name |
|----------------------------------------------------------------------------------|--------------|---------------|
|  | BIM Revit 3D | Downlight ALU |
|  | CAD STEP 3D | DL ALU 14W |

LOGISTICAL DATA

| Product code | Packaging unit (Pieces/Unit) | Dimensions (length x width x height) | Gross weight | Volume |
|---------------|------------------------------|--------------------------------------|--------------|-----------------------|
| 4058075202658 | Folding box 1 | 322 mm x 222 mm x 114 mm | 525.00 g | 8.15 dm ³ |
| 4058075202665 | Shipping box 8 | 658 mm x 466 mm x 263 mm | 4955.00 g | 80.64 dm ³ |

The mentioned product code describes the smallest quantity unit which can be ordered. One shipping unit can contain one or more single products. When placing an order, for the quantity please enter single or multiples of a shipping unit.

ADDITIONAL CATALOG INFORMATION

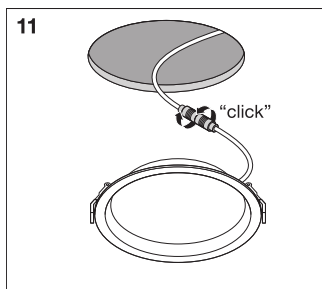

References / Links

– For Guarantee see www.ledvance.com/guarantee

DISCLAIMER

Subject to change without notice. Errors and omission excepted. Always make sure to use the most recent release.