

PRODUCT DATASHEET

BIOLUX HCL DL DN150 ZB 20W 2700-6500K

BIOLUX HCL DOWNLIGHT ZIGBEE GEN 1 | Downlight luminaires, Tunable White, Zigbee



Areas of application

- Lighting solution for up to 40 BIOLUX HCL luminaires - BIOLUX HCL LED strips combined mit BIOLUX HCL control unit
- Open-plan office solution for up to 200 BIOLUX HCL luminaires combined with VIVARES ZIGBEE control unit
- Hotel and office rooms with little daylight

Product benefits

- Enables an individual lighting solution in combination with compatible Zigbee HCL lighting controls
- Biologically optimized lighting by adapting artificial light to natural daylight course
- 7 year system guarantee when operated in a BIOLUX HCL or VIVARES ZIGBEE system
- Can support working with more concentration
- Good glare reduction ($UGR \leq 19$)

Product features

- Zigbee 3.0 certified Tunable White luminaires - LED strips for simple integration into partner systems
- Ready for connection to BIOLUX HCL and VIVARES ZIGBEE control unit
- Adjustable color temperature via Tunable White: 2,700...6,500 K
- Wireless communication between control unit and luminaires via Zigbee protocol
- Very high color rendering index Ra: > 90



TECHNICAL DATA

Electrical data

Nominal wattage	20.00 W
Nominal voltage	220...240 V
Mains frequency	50...60 Hz
Nominal current	93 mA
Inrush current	20 A
Inrush current time T_{h50}	500 μ s
Max. number of luminaires per miniature circuit breaker B16	128
Max. number of luminaires per miniature circuit breaker C10	80
Max. number of luminaires per miniature circuit breaker C16	128
Power factor λ	≥ 0.90
Total harmonic distortion	< 20 %
Protection class	II
Operating mode	External LED driver
Dimming interface	Zigbee 3.0

Photometrical data

Luminous flux	1800 lm
Luminous efficacy	90 lm/W
Color temperature	2700...6500 K
Light color (designation)	Warm White / Cool White / Cool Daylight
Color rendering index Ra	> 90
Standard deviation of color matching	≤ 3 sdc _m
Luminous intensity	-
Low flicker	Yes
Flickering metric (Pst LM)	-
Stroboscope effect metric (SVM)	-
Photobiological safety group acc. to EN62778	RG1
Beam angle	60 °
UGR	< 19

Dimensions & Weight

Diameter	175.40 mm
Height	98.90 mm

Product weight	550.00 g
----------------	----------

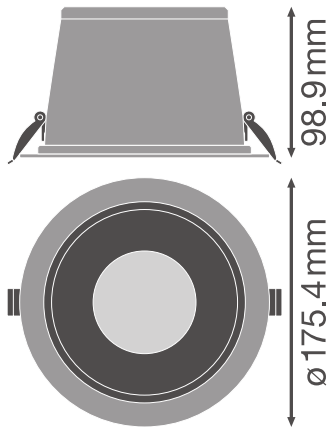

BIOLUX HCL DL DN150 ZB 20W
TW

Materials & Colors

Product color	White
Housing color	White
Body material	Aluminum
Cover material	Polycarbonate (PC)
Light emitting surface material	PMMA
Glow Wire Test according to IEC 60695-2-12	850 °C
Mercury content	0.0 mg

Application & Mounting

Ambient temperature range	-20...+40 °C
Type of connection	Terminal, 3-Pole (L, N, PE)
Type of protection	IP20
Protection class IK (shock resistance)	IK03
Dimmable	Yes
Type of dimming	ZIGBEE
Mounting type	Recessed
Mounting location	Ceiling
Application environment	Indoor
Mounting depth	150 mm
With light source	Yes

Lifespan

Lifespan L70/B50 at 25 °C	50000 h
Lifespan L80/B10 at 25 °C	40000 h
Lifespan L80/B50 at 25 °C	40000 h
Lifespan L90/B10 at 25 °C	25000 h
Number of switching cycles	50000

Certificates & Standards

Standards	CE / CB / ENEC / EAC
Luminaire with limited surface temperature, "D sign"	No
Ball shot safe	No
Replaceable light source (EPREL)	Not replaceable

Accessories Optional

Product image	Product name	EAN
	CONNECTOR BOX 5POLE L/N 4x	4058075473010



EQUIPMENT / ACCESSORIES

















- LEDVANCE BIOLUX app required for commissioning of the BIOLUX HCL system only (available for Android and iOS)
- LEDVANCE VIVARES app for project planning and required for commissioning of the VIVARES ZIGBEE system only (available for Android and iOS)

Safety advice

- Important operating notice and legal disclaimer: This product is exclusively intended for operation as part of a BIOLUX HCL system (BIOLUX HCL- or VIVARES ZIGBEE control unit in combination with BIOLUX HCL-Luminaire(s) / BIOLUX HCL LED strips including built-in or supplied firmware/software). LEDVANCE GmbH assumes no responsibility, liability, warranty or guarantee for the operation of the product in combination or conjunction with third-party products or other products that are not BIOLUX HCL- / VIVARES ZIGBEE system products.

DOWNLOAD DATA

Documents and certificates	Document name
 User instruction / safety instructions	BIOLUX HCL DL DN150 ZB
 Extended installation guide	BIOLUX HCL SYSTEM EN

Documents and certificates		Document name
	Extended installation guide	BIOLUX HCL SYSTEM DE
	Extended installation guide	BIOLUX HCL FR
	Legal information	BIOLUX HCL DL DN150 ZB
	Legal information	BIOLUX HCL DL
	Declarations of conformity	BIOLUX HCL
	Certificates	VDE BIOLUX HCL
	Certificates	VDE BIOLUX HCL
	Certificates	VDE BIOLUX HCL
Photometric and lighting design files		Document name
	IES file (IES)	BIOLUX HCL DL DN150 ZB 20W 6500K
	IES files (IES, additional)	BIOLUX HCL DL DN150 ZB 20W 2700K
	IES files (IES, additional)	BIOLUX HCL DL DN150 ZB 20W 4000K
	LDT file (Eulumdat)	BIOLUX HCL DL DN150 ZB 20W 6500K
	LDT files (Eulumdat, additional)	BIOLUX HCL DL DN150 ZB 20W 2700K
	LDT files (Eulumdat, additional)	BIOLUX HCL DL DN150 ZB 20W 4000K
	ULD file (DIALux)	BIOLUX HCL DL DN150 ZB 20W TW
	ROLF file (RELUX)	BIOLUX HCL DL DN150 ZB
CAD/BIM files		Document name
	BIM Revit 3D	Biolux Tunable White Downlight

CAD/BIM files	Document name
 CAD STEP 3D	HCL DL

LOGISTICAL DATA

Product code	Packaging unit (Pieces/Unit)	Dimensions (length x width x height)	Gross weight	Volume
4058075400733	Folding box 1	189 mm x 189 mm x 141 mm	674.00 g	5.04 dm ³
4058075400740	Shipping box 4	397 mm x 207 mm x 308 mm	3175.00 g	25.31 dm ³

The mentioned product code describes the smallest quantity unit which can be ordered. One shipping unit can contain one or more single products. When placing an order, for the quantity please enter single or multiples of a shipping unit.

References / Links

– For Guarantee see www.ledvance.com/guarantee

Legal advice

– The use of the LEDVANCE BIOLUX- / VIVARES-app is exclusively subject to the LEDVANCE BIOLUX- - VIVARES-app Terms of Use, which are displayed during installation of the app and are available in the app

DISCLAIMER

Subject to change without notice. Errors and omission excepted. Always make sure to use the most recent release.